



Use Manual for model

---

**R1K 25**

---

Premix condensing system boiler  
only heating



#### Contact Details

Office Address: 10 Frankston Gardens Drive,  
Carrum Downs, Victoria, Australia, 3201

Email Address: [sales@hydronicsupplies.com.au](mailto:sales@hydronicsupplies.com.au)

Website: [www.hydronicsupplies.com.au](http://www.hydronicsupplies.com.au)

Phone: (+61 3) 9708 2600

Fax: (+61 3) 9708 2700



## TABLE OF CONTENTS

<b>1. USER SECTION</b>	<b>5</b>
<b>1.1. USE</b>	<b>6</b>
1.1.1. GENERAL USE WARNINGS	6
1.1.2. CONTROL PANEL	7
1.1.3. DISPLAY ICONS	8
1.1.4. INFO MENU DISPLAY DATA	9
1.1.5. START-UP	10
1.1.6. OPERATING MODE	10
1.1.7. INFORMATIONAL NOTE ON ANTI-FREEZE FUNCTION	11
1.1.8. SYSTEM FILLING	12
1.1.9. FAULT SIGNALLING CODES	13
1.1.10. ACTIVE FUNCTIONS SIGNALLING CODES	15
1.1.11. MAINTENANCE	16
1.1.12. COVER CLEANING	16
1.1.13. DISPOSAL	16



## TABLE OF CONTENTS

---



# 1. USER SECTION

The operations described in this section are addressed to all those who will use the machine. The machine must be used and accessed only by qualified operators that fully read and understood the User section, paying particular attention to the warnings.

## 1.1. USE

### 1.1.1. GENERAL USE WARNINGS

**WARNING**

Before starting the boiler the User must make sure that the First start-up certificate has the stamp of the technical Support Centre proving the testing and the first start-up of the boiler.

**WARNING**

To validate the warranty, the boiler must be started by a technical Support Centre authorized by RADIANT no later than 30 days from the date of installation.

**WARNING**

In order to take advantage of the guarantee provided by the manufacturer, the customer should carefully and exclusively observe the instructions given in the USER section of the manual.

**ATTENTION**

This machine may be used only for the purpose for which it has been designed: heat water to a temperature below boiling point at atmospheric pressure. Any other use is considered wrong and dangerous. The manufacturer is excluded from any contractual or out of contract responsibility for damage caused to people, animals or property due to incorrect use.

**DANGER**

The boiler should not be used by persons (including children) with reduced physical, sensory or mental capacities or without suitable knowledge or experience unless they are instructed on the device use or monitored by a person responsible for their safety.

**DANGER**

DO NOT obstruct the air vents of the location in which the gas device is installed to prevent the formation of toxic explosive mixes.

**DANGER**

If you sense a gas odour in the location in which the boiler is installed, proceed as follows:

- > DO NOT use electrical switches, the telephone or any other device that might generate electrical discharges or sparks;
- > Immediately open all doors and windows to create an air exchange that can quickly clean the location;
- > Close the gas valves;
- > Request immediate intervention of qualified staff.

**DANGER**

The use of the electrical power boiler implies respecting some fundamental rules such as:

- > DO NOT touch the device with wet and/or humid parts and/or with bare feet;
- > DO NOT pull the electrical cables;
- > DO NOT leave the device exposed to atmospheric agents (rain, sun, etc.) unless specifically intended;
- > in case of cable damage, turn off the device and contact qualified professional staff to replace it.

## 1.1.2. CONTROL PANEL

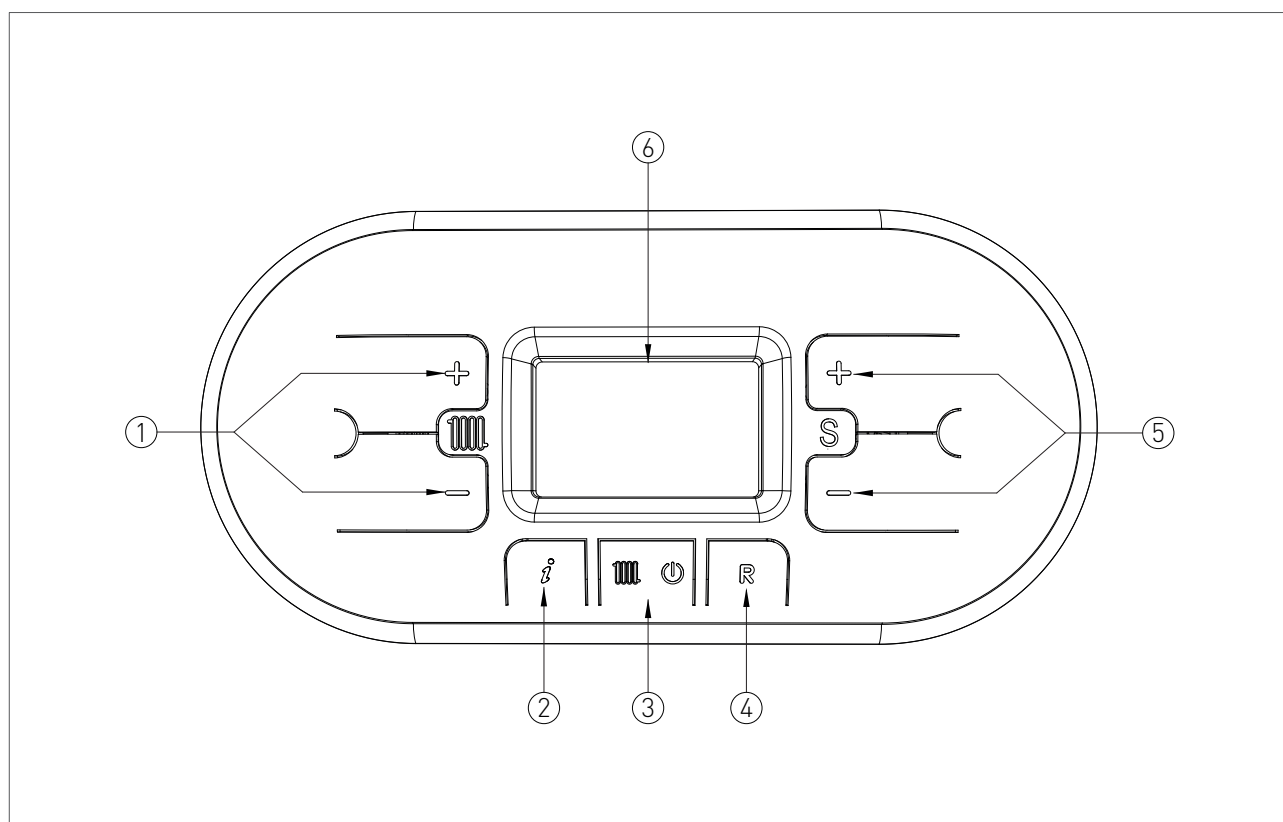

## KEY

1. HEATING TEMPERATURE ADJUSTMENT KEYS
2. INFO KEY: PRESS ONCE TO VIEW THE TEMPERATURES AND OTHER INFORMATION (see chapter 'INFO MENU DISPLAY') - HOLD FOR 5 SECONDS, IN OFF OPERATING MODE, TO VIEW THE LAST 5 FAULTS
3. OPERATING MODE SELECTION KEY: ONLY HEATING / OFF
4. RESET KEY: FAULTS RESET - CHIMNEY SWEEP FUNCTION ACTIVATION (HOLD FOR 7 SECONDS)
5. VALUE OF THE PARAMETERS ADJUSTMENT KEY / HOLD THE KEYS AT THE SAME TIME FOR 5 SECONDS TO ACTIVATE DISPLAY BACK LIGHT FOR 10 MINUTES
6. DISPLAY

### 1.1.3. DISPLAY ICONS

#### KEY



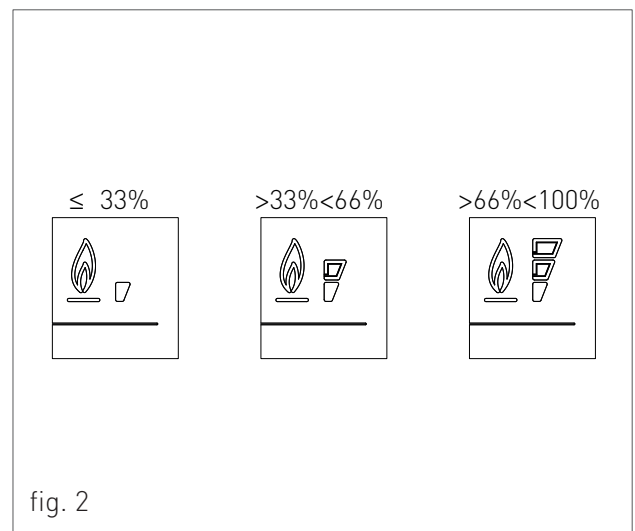
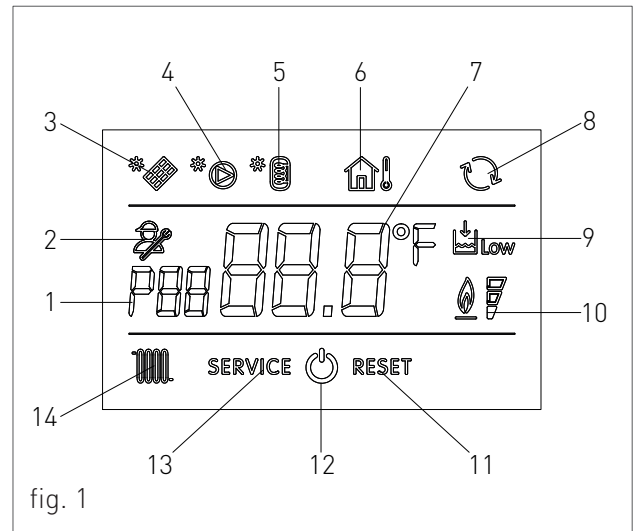

1. INDICATION OF PARAMETER NUMBER OR DISPLAYED INFO CODE
2. PARAMETERS PROGRAMMING FUNCTION ACTIVE
3. SIGNALLING CONNECTED SOLAR BOARD / SOLAR COLLECTOR TEMPERATURE DISPLAY (d5)
4. SOLAR PUMP ACTIVE
5. BOILER LOWER TEMPERATURE DISPLAY (d6) / BOILER UPPER TEMPERATURE DISPLAY (d7)
6. EXTERNAL PROBE INSTALLED / EXTERNAL PROBE TEMPERATURE (d1)
7. TEMPERATURE DISPLAY / SET POINT / PARAMETER VALUE
8. OPEN THERM COMMUNICATION PRESENT (REMOTE CONTROL / AREA CONTROL UNIT)
9. INSUFFICIENT SYSTEM WATER PRESSURE SIGNALLING
10. FLAME PRESENT SIGNALLING / IT ALSO INDICATES, ON 3 PERCENTAGE LEVELS, THE MODULATING POWER LEVEL OF THE BOILER (fig.2)
11. ERROR DISPLAY THAT CAN BE RESET
12. OFF OPERATING MODE
13. ERROR DISPLAY THAT CAN NOT BE RESET
14. OPERATION IN HEATING MODE ENABLED













### 1.1.4. INFO MENU DISPLAY DATA

To view the boiler data from info menu you just have to press the INFO  key. The info code will be displayed on the left side of the screen and its relative value will be displayed on the centre of the screen. Use keys  and  of the heating circuit  to scroll through the list of displayed data. To exit display mode press the INFO  key.

#### LIST OF DISPLAYED DATA

INFO CODE	ICON	DESCRIPTION
d0		DOMESTIC CIRCUIT PROBE TEMPERATURE
d1		EXTERNAL PROBE TEMPERATURE
d2		FAN SPEED
d3		BOTTOM AREA PROBE TEMPERATURE [IF AREA BOARD INSTALLED]
d4		RETURN PROBE TEMPERATURE
d5		SOLAR COLLECTOR TEMPERATURE [IF SOLAR BOARD INSTALLED] (SCS)
d6		SOLAR BOILER TEMPERATURE (BOTTOM) [IF SOLAR BOARD INSTALLED] (SBSI)
d7		SOLAR BOILER TEMPERATURE (TOP) [IF SOLAR BOARD INSTALLED] (SBSS)
d8		SOLAR COLLECTOR PROBE TEMPERATURE 2 [IF SOLAR BOARD INSTALLED] (SCS2)
d9		EXTRA SOLAR BOILER TEMPERATURE [IF SOLAR BOARD INSTALLED] (SBS3)
dA		INERTIAL STORAGE SENSOR TEMPERATURE
dB		LOW-TEMPERATURE HEATING CIRCUIT RETURN SENSOR TEMPERATURE (IN HYBRID SYSTEM BOX MODE) - HEATING PUMP RETURN SENSOR TEMPERATURE (IN HYBRID DOMESTIC SYSTEM MODE)
dC		HYBRID SYSTEM BOX D.H.W. TANK SENSOR TEMPERATURE - HOT WATER TEMPERATURE OUT OF THE REMOTE TANK TO THE BOILER (ONLY FOR HYBRID DOMESTIC SYSTEM WITH OPTIONAL SENSOR)
dD		POWER SUPPLIED BY THE HEATING PUMP IN KW/H (ONLY FOR HYBRID DOMESTIC SYSTEM)
dE		HEATING FLOW RATE DISPLAY EXPRESSED IN L/MIN (IF THERE IS A FLOWMETER).

### 1.1.5. START-UP



Before starting the boiler make sure that it is powered and that the gas tap below the boiler is open.

To start the boiler press the function key  and select the desired operating mode. If the symbol is displayed fixed, it means that the function was activated.

### 1.1.6. OPERATING MODE

#### SUMMER MODE



In this mode the boiler meets only the demands of domestic hot water.

To switch the boiler to SUMMER operating mode, press the function key , the symbol  will appear fixed on the display, indicating that the function is enabled.

Whenever hot domestic water is needed the automatic start-up system will start the burner; this is indicated by displaying the symbol  blinking.

#### ONLY HEATING MODE



In this mode the boiler meets only the demands of heating.



To switch the boiler to ONLY HEATING operating mode, press the function key , the symbol  will appear fixed on the display, indicating that the function is enabled.

Whenever heating energy is needed to heat the rooms the automatic start-up system will start the burner; this is indicated by displaying the symbol  blinking.

#### WINTER MODE



In this mode the boiler meets the demands of heating and of domestic hot water.

To switch the boiler to WINTER operating mode, press the function key , the symbols  and  will appear fixed on the display, indicating that the function is enabled.

Whenever heating energy and domestic hot water are needed the automatic start-up system will start the burner; this is indicated by displaying the symbol  and  blinking.

#### ADJUSTING THE HEATING TEMPERATURE



You can adjust the temperature using keys  and  of the heating circuit .

- press key  to decrease the temperature.
- press key  to increase the temperature.

The heating temperature adjustment field ranges from 30 °C to 80 °C (25 °C – 45 °C for floor systems).

#### DOMESTIC HOT WATER TEMPERATURE ADJUSTMENT

You can adjust the temperature using keys  and  of the domestic circuit .

- press key  to decrease the temperature.
- press key  to increase the temperature.



The hot domestic water temperature adjustment field ranges from 35 °C to 60 °C.

#### OFF MODE

In this mode the boiler no longer meets the heating and domestic hot water demands, the anti-freeze,



pump anti-locking and diverter valve anti-locking systems still remain active.

To switch the boiler to OFF operating mode, press the function key , the symbol  will appear fixed on the display, indicating that the function is enabled (for non condensing models will appear the message 'OFF').

If the boiler was previously running, it will be turned off and the post-ventilation and post-circulation functions will be enabled.

If you have to deactivate the boiler for a long period of time, proceed as follows:

- › contact the Technical support centre that will empty the water system, where no anti-freeze is intended, and will cut off the power, water and gas supply.
- › Or leave the boiler in OFF operating mode keeping active the electrical and gas supplies so that the anti-freeze function may activate.

### 1.1.7. INFORMATIONAL NOTE ON ANTI-FREEZE FUNCTION

The boiler is protected against freezing thanks to the electronic board preparation with functions that start the burner and heat the concerned parts when their temperature goes below the minimum pre-set values.



#### WARNING

*This function is available only if:*

- › the boiler is powered;
- › the gas supply is open;
- › the pressure of the system is proper;
- › the boiler is not blocked.

### 1.1.8. SYSTEM FILLING

To restore the water pressure inside the system open the loading tap "R" (fig. 1) and make sure using pressure gauge "M" (fig. 1), that the system pressure reaches 1.2 bar (see fig. 2).

After performing this operation, make sure that the loading tap "R" (fig. 1) is properly closed.

After the water pressure reset the boiler will automatically perform a 2 minutes system relief cycle. Throughout this function the display will show the code "F33". The boiler can work normally only after completing the operation.

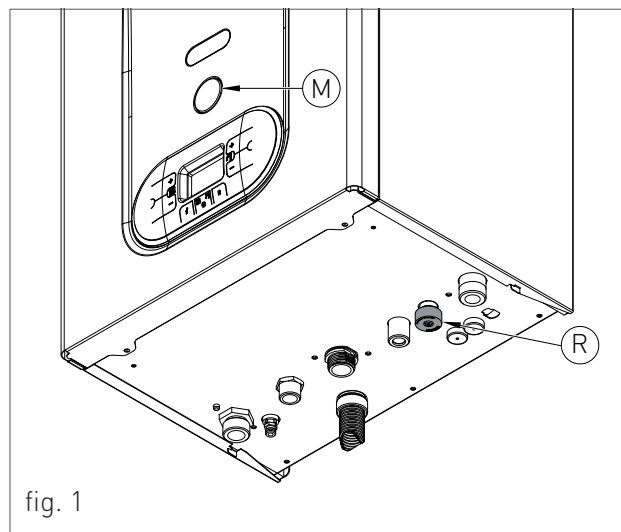

fig. 1

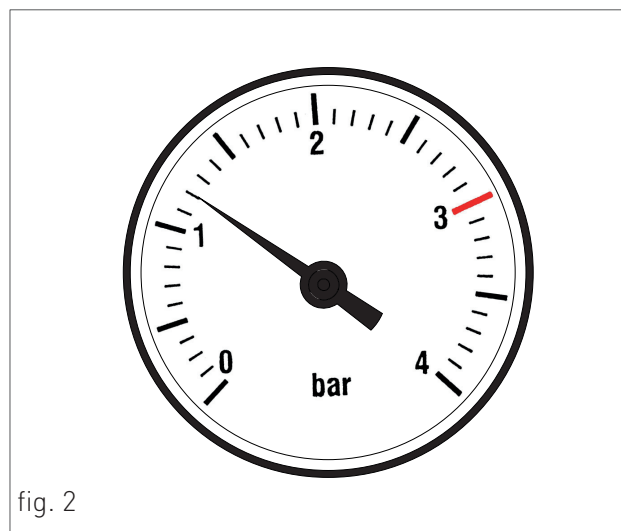



fig. 2



### 1.1.9. FAULT SIGNALLING CODES

The boiler might signal some faults by displaying a code. Below you have a list of the codes and of the operations to be performed in order to unlock the boiler.

CODE	ICON	FAULT	INTERVENTION
E01	RESET	<b>FLAME BLOCK</b>	<p>MAKE SURE THAT THE BOILER AND CONTACTOR GAS VALVES ARE OPEN.</p> <hr/> <p>PRESS THE RESET  BUTTON ON THE CONTROL PANEL TO RESET THE FAULT, AS SOON AS THE ERROR CODE DISAPPEARS FROM THE DISPLAY, THE BOILER WILL START AUTOMATICALLY.</p> <hr/> <p>IF THE BLOCK PERSISTS CONTACT THE TECHNICAL SUPPORT CENTRE.</p>
E02	RESET	<b>SAFETY THERMOSTAT (95 °C)</b>	CONTACT THE TECHNICAL SUPPORT CENTRE.
E03	RESET	<b>FUMES SAFETY THERMOFUSE (102 °C)</b>	CONTACT THE TECHNICAL SUPPORT CENTRE.
E04		<b>WATER MISSING IN THE SYSTEM</b>	<p>IF THE SYSTEM PRESSURE IS BELOW 1.2 BAR, FILL THE SYSTEM AS DESCRIBED IN CHAPTER "SYSTEM FILLING".</p> <hr/> <p>IF THE BLOCK PERSISTS CONTACT THE TECHNICAL SUPPORT CENTRE.</p>
E05	SERVICE	<b>HEATING PROBE</b>	CONTACT THE TECHNICAL SUPPORT CENTRE.
E10	SERVICE	<b>LOW FLOW RATE</b>	CONTACT THE TECHNICAL SUPPORT CENTRE.
E15	SERVICE	<b>RETURN PROBE</b>	CONTACT THE TECHNICAL SUPPORT CENTRE.
E16	SERVICE	<b>ELECTRIC FAN</b>	CONTACT THE TECHNICAL SUPPORT CENTRE.
E18	SERVICE	<b>INSUFFICIENT CIRCULATION</b>	CONTACT THE TECHNICAL SUPPORT CENTRE.
E21	SERVICE	<b>GENERAL INTERNAL BOARD ERROR</b>	<p>CUT OFF THE POWER SUPPLY FROM THE MAIN SWITCH AND THEN RESTORE IT, AS SOON AS THE ERROR CODE DISAPPEARS, THE BOILER WILL RESTART AUTOMATICALLY.</p> <hr/> <p>IF THE BLOCK PERSISTS CONTACT THE TECHNICAL SUPPORT CENTRE.</p>



### 3. USE

CODE	ICON	FAULT	INTERVENTION
E22	SERVICE	<b>PARAMETERS PROGRAMMING REQUEST</b>	CUT OFF THE POWER SUPPLY FROM THE MAIN SWITCH AND THEN RESTORE IT, AS SOON AS THE ERROR CODE DISAPPEARS, THE BOILER WILL RESTART AUTOMATICALLY.  IF THE BLOCK PERSISTS CONTACT THE TECHNICAL SUPPORT CENTRE.
E31	SERVICE	<b>INCOMPATIBLE REMOTE CONTROL</b>	CONTACT THE TECHNICAL SUPPORT CENTRE.
E32	SERVICE	<b>COMMUNICATION ERROR BETWEEN THE BOILER BOARD AND THE MODBUS BOARD</b>	CONTACT THE TECHNICAL SUPPORT CENTRE.
E35	RESET	<b>RESIDUAL FLAME</b>	PRESS THE RESET  BUTTON ON THE CONTROL PANEL TO RESET THE FAULT, AS SOON AS THE ERROR CODE DISAPPEARS FROM THE DISPLAY, THE BOILER WILL START AUTOMATICALLY.
E40	SERVICE	<b>SUPPLY VOLTAGE</b>	CONTACT THE TECHNICAL SUPPORT CENTRE.
E52	SERVICE	<b>COMMUNICATION FAULT BETWEEN MODBUS CONTROLLER AND MODBUS CONTROL UNIT</b>	CONTACT THE TECHNICAL SUPPORT CENTRE.



### 1.1.10. ACTIVE FUNCTIONS SIGNALLING CODES

CODE	FUNCTION	INTERVENTION
F08	<b>HEATING ANTI-FREEZE FUNCTION ACTIVE</b>	WAIT UNTIL THE OPERATION IS COMPLETED
F33	<b>SYSTEM AIR RELEASE CYCLE IN PROGRESS</b>	WAIT UNTIL THE OPERATION IS COMPLETED



#### 1.1.11. MAINTENANCE

To ensure proper boiler safety and efficiency, please contact RADIANT technical support network to check the device every year.

An accurate maintenance should improve system management.

#### 1.1.12. COVER CLEANING

Clean the cover of the device using a wet cloth and come neutral soap.



**WARNING**

*DO NOT use abrasive or powder detergents as they might damage the plastic cover and control elements.*

#### 1.1.13. DISPOSAL

The boiler and all its accessories must be differentiated, suitably disposed of in accordance with the standards in force.



The use of the symbol WEEE (Waste Electrical and Electronic Equipment) shows that this

product can not be dismantled as domestic waste. Proper dismantle of this product helps preventing potentially negative consequences on human health and environment.











**RADIANT BRUCIATORI s.p.a.**

Via Pantanelli, 164/166 - 61025 Loc. Montelabbate (PU)

Tel. +39 0721 9079.1 • fax. +39 0721 9079279

e-mail: [info@radiant](mailto:info@radiant) • Internet: <http://www.radiant.it>